

Uniden[®]

DECT 1535 Series

For more exciting new products please visit our website:

Australia: www.uniden.com.au

New Zealand: www.uniden.co.nz

OWNER'S MANUAL

Important Safety Instructions!

When using your telephone equipment, basic safety precautions should always be followed to reduce the risk of fire, electric shock and injury to persons, including the following:

- **This unit is NOT waterproof.** DO NOT expose this unit to rain or moisture.
- Do not use this product near water, for example, near a bath tub, wash bowl, kitchen sink or laundry tub, in a wet basement or near a swimming pool.
- Avoid using a telephone (other than a cordless type) during an electrical storm. There may be a remote risk of electric shock from lightning.
- Do not use the telephone to report a gas leak in the vicinity of the leak.
- Use only the power cord and batteries indicated in this manual. Do not dispose of batteries in a fire. They may explode. Check with local codes for possible special disposal instructions.
- Do not place the handset in any charging cradle without the battery installed and the battery cover securely in place.

SAVE THESE INSTRUCTIONS!

CAUTION! Risk of explosion if battery is replaced by an incorrect type! Dispose of used batteries according to the instructions. Do not open or mutilate the battery. Disconnect the battery before shipping this product.

Important Notice:

- Under power failure conditions this appliance may not operate. Please ensure that a separate telephone, not dependent on local power, is available for emergency use.

General Notices for New Zealand Model:

- The grant of a NZ Telepermit for any item of terminal equipment indicates only that Spark has accepted that the item complies with minimum conditions for connection to its network. It indicates no endorsement of the product by Spark, nor does it provide any sort of warranty. Above all, it provides no assurance that any item will work correctly in all respects with another item of Telepermitted equipment of a different make or model, nor does it imply that any product is compatible with all of Spark's network services.
- The maximum volume setting of this telephone exceeds the Spark specified volume requirement. Spark takes no responsibility for the high volume available on this telephone, customer's who believe this telephone is too loud should contact the manufacturer at the website indicated on owner's manual warranty page.
- For telephone networks other than Spark there may be a charge incurred for local calls if the Insert 0 feature is on. Turn Insert 0 off.
- This equipment may not provide for the effective hand-over of a call to another device connected to the same line.

DECT 1535 Series Owner's Manual

What's in the box?

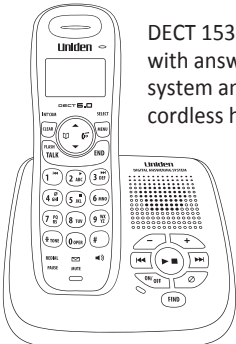

DECT 1535 base with answering system and cordless handset

Not pictured:

- Rechargeable battery (BT-694m)
- Battery Cover
- AC adapter (AAD-041S(M))
- Telephone cord
- Wall Mount Bracket

You will also find:

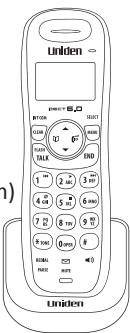

Accessory handset and charger

Not pictured:

- Rechargeable battery (BT-694m)
- Battery cover
- AC adapter (AAD-600S(M))

If you purchased model number:	You should have:
DECT 1535+1	1 of each
DECT 1535+2	2 of each
DECT 1535+3	3 of each

- If any items are missing or damaged, contact your place of purchase immediately. Never use damaged products!
- Need Help? Get answers at our website:

www.uniden.com.au for Australian model
www.uniden.co.nz for New Zealand model

CONTENTS

Getting Started	5
Installing Your Phone	5
Getting to Know Your Phone.....	6
Using the Menu.....	10
Handset Setup Menu.....	11
Ans Setup Menu	11
Day & Time Setup Menu.....	11
Global Setup Menu.....	12
Entering Text on You Phone	12
Using Your Phone	13
Basics.....	13
Changing the Volume	13
Using the Caller ID and Redial Lists.....	13
Using Call Waiting.....	15
Using the Phonebook.....	15
Finding a Lost Handset.....	16
Using Special Features	17
Chain Dialing	17
Multihandset Features.....	17
Conference Calling.....	17
Privacy Mode	17
Intercom	18
Call Transfer.....	18
Voice Message Notification.....	18
Using the Answering System	20
Answering System Options (Ans. Setup).....	20
Accessing the Answering System	21
Personalizing the Greeting	21
Getting Your Messages	22
Using the System While You're Away from Home	24
Solving Problems	25
AC Adapter and Battery Information	30
Mounting the Base on a Wall.....	30
Index	32
One-year Limited Warranty	34

GETTING STARTED

Installing Your Phone

Charge the Battery

1. Unpack all handsets, battery packs, and battery covers. If you need to remove a battery cover, press in on the notch and slide the cover down and off.
 2. Line up the battery connector with the jack inside the handset. (The battery connector will only fit one way.)
 3. Push the connector in until it clicks into place; tug gently on the wires to make sure the battery pack is securely connected.
 4. Replace the battery cover and slide it into place.
 5. Connect the AC adapters to the **DC IN 9V** jacks on the base and on each charger. Set the plugs into the notches.
 6. Plug the other end of the adapters into standard 240V AC outlets.
 7. Place one handset in the base and the other(s) in the charger(s) with the displays facing forward. The charge LED on each handset should light up; if it doesn't, reseal the handset or try plugging the AC adapter into a different outlet.
-  **Charge all handsets completely (about 15 hours) before using them.**

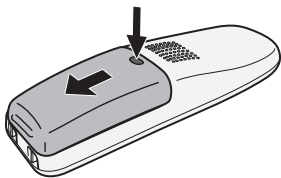

Connect the Telephone Cord

Use the telephone cord to connect the **TEL LINE** jack on the base to a standard telephone wall jack.

Test the Connection

1. Pick up the handset from the cradle and press **TALK**. You should hear a dial tone, and the display should say *Talk*.

- If you don't hear a dial tone or the display says *Check Tel Line*, try checking the connection between the base and the phone jack.
2. Make a quick test call. (Press **END** to hang up.)
 - If there is a lot of noise, see page 27 for tips on avoiding interference.
 3. Test all your handsets the same way. If you can't get a dial tone, try moving the handset closer to the base.

Getting to Know Your Phone

Parts of the base

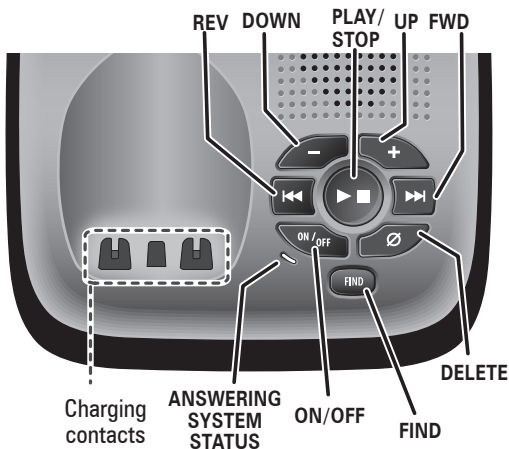

Base keys/LEDs and how they work

Key (icon)	What it does
UP (+)	<ul style="list-style-type: none">- In standby: increase the ringer volume.- While a message is playing: increase the speaker volume.
DOWN (-)	<ul style="list-style-type: none">- In standby: decrease the ringer volume.- While a message is playing: decrease the speaker volume.
FWD (▶▶)	<ul style="list-style-type: none">- While a message is playing: skip to the next message.
REV (◀◀)	<ul style="list-style-type: none">- While playing messages: for the first 2 seconds, go to the previous message; after that: go to the start of the current message.
PLAY/ STOP (▶ ■)	<ul style="list-style-type: none">- In standby: start playing messages.- While a message is playing: stop playing messages.- If the phone is ringing: mute the ringer for this call only.
ON / OFF	<ul style="list-style-type: none">- In standby: turn the answering system on or off.
DELETE (⊘)	<ul style="list-style-type: none">- While a message is playing: delete this message.- In standby: delete all messages.
FIND	<ul style="list-style-type: none">- In standby: page all handsets.
LED	What it means
PLAY/ STOP	<ul style="list-style-type: none">- On: a message is playing.- Blinking: there are new messages.
STATUS	<ul style="list-style-type: none">- On: the answering machine is on.- Off: the answering machine is off.- Blinking: the base is paging all handsets.

Parts of the handset

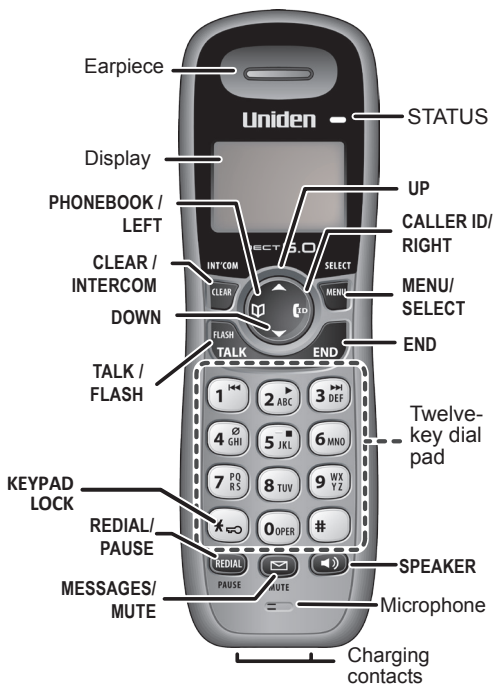









Handset keys/LEDs and how they work

Key (icon)	What it does
CLEAR/ INTERCOM	<ul style="list-style-type: none"> - In standby: start an intercom call. - During a call: put the call on hold and start a call transfer to another handset. - While entering text: delete one character, or press and hold to delete all the characters.

Key (icon)	What it does
TALK/FLASH	<ul style="list-style-type: none"> - In standby: start a telephone call (get a dial tone). - During a call: switch to a waiting call.
END	<ul style="list-style-type: none"> - During a call: hang up. - In the menu or any list: exit and go to standby.
MENU/SELECT	<ul style="list-style-type: none"> - In standby: open the menu. - In the menu or any list: select the highlighted item.
UP (▲)	<ul style="list-style-type: none"> - In standby: increase the ringer volume. - During a call: increase the audio volume. - In any menu or list: move the cursor up one line.
DOWN (▼)	<ul style="list-style-type: none"> - In standby: decrease the ringer volume. - During a call: decrease the audio volume. - In any menu or list: move the cursor down one line.
PHONEBOOK/ LEFT (📖)	<ul style="list-style-type: none"> - In standby or during a call: open the phonebook. - In the menu: go back to the previous screen. - During text entry: move the cursor to the left.
CALLER ID/ RIGHT (📞ID)	<ul style="list-style-type: none"> - In standby or during a call: open the Caller ID list. - During text entry: move the cursor to the right.
REDIAL/ PAUSE	<ul style="list-style-type: none"> - In standby: open the redial list. - While entering a phone number: insert a 2-second pause.
MESSAGES/ MUTE (✉)	<ul style="list-style-type: none"> - In standby: access your answering system. - During a call: mute the microphone. - If the phone is ringing: mute the ringer for this call only. Applies to individual handset ringer only.
KEYPAD LOCK (🔒)	<ul style="list-style-type: none"> - In standby: press and hold to lock or unlock the keypad.
SPEAKER (🔊)	<ul style="list-style-type: none"> - Switch a normal call to the speakerphone (& back).
LED	What it means
STATUS	<ul style="list-style-type: none"> - On: the battery is charging. - Blinking: there are new messages.

Reading the Display

This table shows possible status icons and what they mean. Since the icons appear based on what you're doing with the phone, you won't ever see all of these icons at the same time.

Icon	What it means
	The ringer is turned off and will not ring for new calls.
	You have a voice message waiting.
	Privacy Mode is on: no other handset can join the call.
	The speakerphone is on.
	The microphone is muted; the caller can't hear you.
	T-coil mode is on (see page 26).
	The battery is 1) fully charged, 2) half charged, 3) getting low, or 4) empty.
	Enter 1) capital or 2) lower case letters (see page 12).

Using the Menu

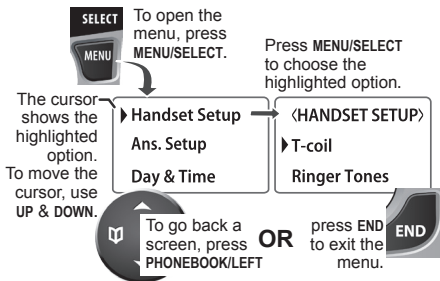

- If you open the menu during a call, use **LEFT** to back out of the menu without hanging up.
- If you don't press any keys for about thirty seconds, the handset exits the menu.

Handset Setup Menu

You can change these settings separately for each handset.

<i>T-coil</i>	Turn on T-coil mode to reduce noise on some hearing aids (for more details, see page 26).
<i>Ringer Tones</i>	Choose this handset's ring tone. As you highlight each ring tone, the phone plays a sample. When you hear the tone you want, press MENU/SELECT .
<i>AutoTalk</i>	Have this handset answer a call when you pick it up from the cradle (without pressing any buttons).
<i>Any Key Answer</i>	Have this handset answer a call when you press any key on the 12-key dialpad.
<i>Banner</i>	Change the name used on the handset's display.
<i>Key Touch Tone</i>	Have the keypad sound a tone when you press a key.

Ans Setup Menu

Refer to page 20 for details on setting up your answering system.

Day & Time Menu

Use this menu to set the clock manually. (If you have Caller ID, the phone sets the day and time from the CID data.) Select the day of week, then use the number keypad to enter the hour and minutes in HHMM format (e.g., enter 0345 for 3:45). Then, select AM or PM.

Global Setup **Menu**

The settings on this menu affect all handsets. Only one handset at a time can change these menu options.

<i>Set Line Mode</i>	Do not change this setting unless instructed to by customer service.
<i>Insert 0</i>	This feature adds “0” or “00” at the beginning of the number received from Caller ID. The default setting for New Zealand is ON. The default setting for Australia is OFF.
<i>Edit Voice Mail</i>	If you subscribe to a Voice Mail service you can set the Voice Mail number (see page 20).
<i>VMWI Reset</i>	Reset your Visual Message Waiting Indicator to bring it back in sync with your voice mail service.

Entering Text on Your Phone

Use the 12-key dial pad when you want to enter text into your phone (a name in the phonebook, the handset banner, etc.).

- The phone defaults to a capital letter for the first letter and any letter after a space; otherwise, it uses small letters.
- To switch to all capital letters, press *****. The phone defaults to all capital letters first (e. g. ABCabc2) until you enter a blank space or press ***** again. (Any time you want to change case, just press *****.)
- If two letters in a row use the same number key, enter the first letter and wait a few seconds (or press **RIGHT**); the cursor will move to the next space. Enter the next letter.
- Press **#** to enter a blank space.
- To change a letter, move the cursor to that letter and press **CLEAR** to erase the letter. Then, enter the new one.
- To erase the entire entry, press and hold **CLEAR**.
- Press **0** to cycle through all available symbols and punctuation.

USING YOUR PHONE

Basics

To...	Earpiece	Speakerphone
make a call: Dial the number, then	Press TALK/FLASH .	Press SPEAKER .
answer a call	Press TALK/FLASH .	Press SPEAKER .
hang up	Press END or put the handset in the cradle.	
switch between the speaker & earpiece	Press SPEAKER .	
mute the microphone during a call	Press MESSAGES/MUTE . Press again to turn the microphone back on.	
put a call on hold	Press CLEAR/INTERCOM . After 5 minutes on hold, the call will be disconnected.	
return to a call on hold	Press TALK/FLASH .	Press SPEAKER .
mute the ringer for this call only	While the phone is ringing, press MESSAGES/MUTE . Applies to individual handset ringer only.	

Changing the Volume

You can set speaker volume levels separately for each handset. You can also set the earpiece volume on each handset. Anytime you are listening to a speaker or earpiece, press **UP** to increase the volume and **DOWN** to decrease it.

You can also set the ringer volume separately: when the phone is in standby, press **UP** to increase the ringer volume and **DOWN** to decrease. If you turn the ringer volume all the way down, the ringer turns off.

Using the Caller ID and Redial Lists

Caller ID (CID) is a service available from your telephone provider that shows the phone number (and sometimes the caller's name) of incoming calls. Contact your telephone provider for more information.

Caller ID list	Redial list
<ul style="list-style-type: none"> - When a call comes in, the phone displays the number and name (if available) of the caller. - The phone saves the information for the last 30 received calls to the <i>CID list</i>. - When it's in standby, the handset shows how many calls came in since the last time you checked the CID list. 	<ul style="list-style-type: none"> - Each handset remembers the last 5 numbers you dialed on it. The redial list is separate for each handset.

 **All handsets share the CID list; only one handset can access the CID list at a time.**

To...	Follow these steps:
Open the CID list	Press CALLER ID/RIGHT .
Open the redial list	REDIAL/PAUSE .
Scroll through the lists	Press DOWN to scroll from newest to oldest. Press UP to scroll from oldest to newest.
Dial a number from the lists	Highlight the number you want and press TALK/FLASH or SPEAKER .
Close the lists	Press PHONEBOOK/LEFT .

To select a number, highlight the number and press **MENU/SELECT**. The phone gives you the following options:

<i>Delete Entry</i>	Erase the number from the list.
<i>Store Into PB</i>	Add the number to the phonebook. The handset prompts you to edit the name and number.
<i>Delete All</i>	(CID list only) Erase all numbers from the list.

Using Call Waiting

Call Waiting, a service available from your telephone provider, lets you receive calls while you are on another call. Caller ID on Call Waiting (CIDCW) service displays Caller ID information for a waiting call.

For Australian model:

Press **TALK/FLASH** and then press **2** to accept the waiting call. The first caller is put on hold, and you will hear the new caller after a short pause. To return to the original caller, press **TALK/FLASH** and then **2** again.

For New Zealand model:

Press **TALK/FLASH** on the handset to accept the waiting call. The first caller is put on hold, and you will hear the new caller after a short pause. To return to the original caller, press **TALK/FLASH** again.

Using the Phonebook

The phone can store up to 70 entries in its phonebook. All handsets share the same phonebook, so only one handset may access the phonebook at a time.

To...	Press...
Open/close the phonebook	PHONEBOOK/LEFT.
Scroll through the entries	DOWN (to scroll through the phonebook from A to Z) or UP (to scroll from Z to A).
Jump to entries that start with a certain letter	the number key corresponding to the letter you want.
Dial an entry	UP or DOWN to find the entry you want to dial, then press TALK/FLASH or SPEAKER .

Phonebook Menu Options

Open the phonebook with the phone in standby, then press **MENU/SELECT** to open the phonebook menu. Choose one of these options:

<i>Create New</i>	Add an entry to your phonebook. The phone prompts you to enter a name and number.
<i>Delete All</i>	Erase all the entries in the phonebook.

- If you need the phone to pause before sending the next set of digits, press **REDIAL/PAUSE** to insert a 2-second pause. The pause shows as a **P** in the display.
- You can insert as many pauses as you need, but each pause counts as one of your 20 digits.

Phonebook Entry Options

With the phone in standby, open the phonebook and find the entry you want. Press **MENU/SELECT** to open the individual phonebook entry menu. The phone prompts you to edit or delete the entry.

Finding a Lost Handset

With the phone in standby, press **FIND** on the base. All the handsets will beep in a 3-beep pattern for 1 minute or until you press **FIND** again. You can also end the page by pressing any key from the found handset.

USING SPECIAL FEATURES

Chain Dialing

If you often have to enter a series of digits or a code number during a call, you can save that code number to a phonebook entry and use the phonebook to send the code number.

1. Enter the code number (up to 20 digits) into the phonebook just like a regular phonebook entry. Be sure to enter the code number into the phonebook exactly as you would enter it during a call.
2. When you hear the prompt that tells you to enter the number, open the phonebook and find the entry that contains your code number. Press **MENU/SELECT** to transmit the code. The phone transmits the code number entered in the previous step. If you change your mind, use **PHONEBOOK/LEFT** to close the phonebook.

Multihandset Features

Conference Calling

When an outside call comes in, two handsets can join in a conference call with the outside caller.

- To join the call, just press **TALK/FLASH** or **SPEAKER**.
- To leave the conference call, hang up normally; the other handset remains connected to the call.

Privacy Mode

To prevent other handsets from joining a call:

1. Start your call as usual, then press **MENU/SELECT**. The display shows *Call Privacy*.
2. Press **MENU/SELECT** again to turn privacy mode on (you'll see a  in the display).
 - Privacy mode turns off automatically when you hang up.
 - As long you have privacy mode on, no other handsets can interrupt your call. To accept another handset in the call, turn privacy mode off by repeating the process above (press **MENU/SELECT** twice).

Intercom

- Whenever the phone is in standby, you can make an intercom call between handsets without using the phone line.
- You can make an intercom call from any handset, but only two handsets can be in an intercom call at any time.
- If an outside call comes in during an intercom page, the phone cancels the page so you can answer the incoming call.
- If an outside call comes in during an intercom call, press **TALK/FLASH** to hang up the intercom call and answer the outside call.

To...	Follow these steps:
make an intercom page	<ol style="list-style-type: none">1. Press CLEAR/INTERCOM.2. Select the handset you want to talk with, or <i>All</i> to page all handsets at the same time.
cancel a page	Press END .
answer a page	Press CLEAR/INTERCOM or TALK/FLASH .
end an intercom call	Press END . Both handsets return to standby.

Call Transfer

To...	Follow these steps:
transfer a call	<ol style="list-style-type: none">1. Press CLEAR/INTERCOM to put the call on hold.2. Select the handset you want to page (select <i>All</i> to page all handsets at the same time).3. When another handset accepts the call, you'll be disconnected (press TALK/FLASH to rejoin the call).
cancel a transfer	Press TALK/FLASH to return to the call.
accept a transferred call	<ol style="list-style-type: none">1. To answer the page and speak to the transferring handset using the intercom, press CLEAR/INTERCOM.2. To speak to the outside caller, press TALK/FLASH.

Voice Message Notification

- If you subscribe to a voice mail service, your phone can notify you when you have a new message waiting. This feature supports Frequency-Shift Keying (FSK) message notification. Contact your voice mail provider for information.

- When you have new messages, the voice message icon appears in the display, and the **STATUS** light on the handset blinks.
- After you listen to your messages, the voice message icon turns off. If it doesn't, you can reset it: With the phone in standby, open the menu and select *Global Setup*; select *VMWI Reset*, then select *Yes*.

Setting Up Your Voice Mail

When you sign up for a voice mail service, your service provider should give you an *access number*. If you don't have this information, contact your provider before you start.

1. With the phone in standby, open the menu.
2. Select *Global Setup*, then select *Edit Voice Mail*. For the New Zealand model the Spark access number (083210) is preprogrammed.
3. Enter your access number exactly as you would dial it. You can enter a total of 20 digits. If you need the phone to wait for a few seconds between digits (to wait for the service to answer, for example), press **REDIAL/PAUSE** to insert a 2-second pause. If two seconds isn't long enough, you can insert as many pauses as you need, but each pause counts as one digit. Press **SELECT/MENU** when you're finished.

Getting Your Messages

1. Press **MESSAGES** (✉)/**MUTE** and then **MENU/SELECT** to dial the access number you programmed into this handset.

Resetting the voice message indicator

If the voice message icon remains after you check your messages, you can reset it.

1. With the phone in standby, open the menu.
2. Select *Global Setup*, then select *VMWI Reset*.
3. Select *Yes*.

USING THE ANSWERING SYSTEM

Answering System Options (*Ans. Setup*)

You can set or change the answering system options from any handset. Just open the menu and select *Ans. Setup*. Select one of the following:

<i>Security Code</i>	Enter a 2-digit PIN so you can access your answering system from any touch-tone phone (see page 24).
<i>Ring Time</i>	Set the number of rings (6, 9 or 12) before the answering system answers the phone. Choose <i>Toll Saver</i> to have the system pick up after 2 rings if you have new messages or after 4 rings if you don't.
<i>Record Time</i>	Set the amount of time (1 or 4 minutes) callers have to leave a message. Choose <i>Announce Only</i> if you don't want the system to let callers to leave a message.
<i>Message Alert</i>	Have the system beep every 15 seconds when you have a new message; the beeping stops when you listen to all your new messages. (To mute the alert without listening to your messages, press any key on the base.)
<i>Call Screen</i>	Turn on the call screen feature so you can hear callers as they leave messages on the base speaker (see page 23).
<i>Ans. On/off</i>	Turn your answering system on or off. (To turn your system on or off from the base, just press ON/OFF .)

Accessing the Answering System

You can access your system from a handset whenever the phone is in standby.

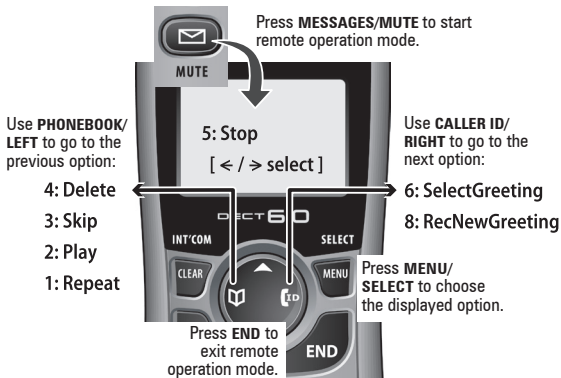

- During remote operation, the phone beeps to let you know it's waiting for your next command.
- You can press the number key next to the commands instead of scrolling through them.
- If you take no action for 30 seconds, the phone returns to standby.
- Only one handset can access the system at a time.

Personalizing the Greeting

- Your personal outgoing message or *greeting* can be between 3 seconds and 30 seconds long.
- If you don't want to record a greeting, the system uses a pre-recorded greeting: *Hello, no one is available to take your call. Please leave a message after the tone.*
- After you record a greeting, you can switch between the pre-recorded greeting to your personal greeting at any time.

Record a Personal Greeting

1. Access the answering system from any handset. Wait until the system finishes its announcements, or press **5** (*Stop*) to skip them.
2. Press **8** (*RecNewGreeting*).
3. Wait for the system to say "Record greeting," then begin speaking.
4. When you're finished, press **8** to stop recording. The system plays back your new greeting.
5. To keep this greeting, press **END**. To re-record it, go back to step 2.

Switch Between the Two Greetings

1. Access the answering system from any handset. Wait until the system finishes its announcements or press **5** (*Stop*) to skip them.
2. Press **6** (*SelectGreeting*) to play back the current greeting.
3. Press **6** again to switch greetings.

Delete Your Greeting

Switch to your personal greeting following the steps above, then press **4** (*Delete*) while the system is playing back your greeting.

Getting Your Messages

To...	From the base	From a handset (remote operation)
play new messages	Press PLAY/STOP . The system announces the number of new and old messages, then plays each new message (followed by the day and time) in the order it was received.	Press MESSAGES/MUTE .
replay an earlier message	Within 2 seconds after a message starts playing, press REV .	select 1:Repeat .

To...	From the base	From a handset (remote operation)
restart the current message	Wait at least 3 seconds after a message starts playing, then press REV.	Wait at least 5 seconds after a message starts playing, then select 1: Repeat.
skip a message	Press FWD.	Select 3:Skip.
delete a message	While the message is playing, press DELETE.	While the message is playing, Select 4:Delete.
delete all of your messages	With the phone in standby, press DELETE. When prompted, press DELETE again.	Not available.
play old messages	After the system plays all new messages, press PLAY/STOP again.	Select 2:Play.
stop playback	press PLAY/STOP.	Select 5:Stop.

Screening Your Calls

Another feature your answering system gives you is *call screening*. While the system is taking a message, you can hear the caller on the base speaker (if you turn on *Call Screen*) or from a handset. Only one handset at a time can screen calls. If another handset tries to screen the call, the second handset beeps and returns to standby.

To...	From the base	From a handset
hear the caller leaving a message	Listen to the caller over the speaker.	Press MESSAGES/MUTE.
answer the call	NA	Press TALK/FLASH.
mute the call screen without answering*	Press PLAY/STOP.	Press END or return the handset to the cradle.

* If you mute the call screen, the system continues taking the message: it just stops playing through the speaker.

Using the System While You're Away from Home

You can also use your answering system from any touch-tone phone. Before you can use this feature, you must program a security code.

Programming a security code

1. With the phone in standby, open the menu from any handset.
2. Select *Ans. Setup*, then select *Security Code*.
3. Use the number keypad to enter a two-digit security code (00 to 99). Press **MENU/SELECT** when you're finished.

 **Remember to make a note of your new security code!**

Dialing In to Your System

1. Call your telephone number and wait for the system to answer. (If your answering system is off, it will answer after 15 rings and sound a series of beeps instead of your greeting.)
2. During the greeting or beeps, press **#** and **immediately** enter your security code. If you enter it incorrectly 3 times, the system hangs up and returns to standby.
3. The system announces the current time, the number of messages stored in memory, and a help prompt. It will beep intermittently to let you know it's waiting for your command.
4. When you hear beeping, enter a 2-digit command from this chart:

#1	Repeat message	#5	Stop playback
#2	Play message	#6	Turn the system on
#3	Skip message	#9	Turn the system off
#4	Delete message	#0	Hear help prompts

 **If you don't press any keys for 15 seconds, the system hangs up and return to standby.**

SOLVING PROBLEMS

If you have any trouble with your phone, try these simple steps first. If you need help, visit our website listed on the front cover.

If...	Try...
No handsets can make or receive calls.	<ul style="list-style-type: none">- Checking the telephone cord connection.- Disconnecting the base AC adapter. Wait a few minutes, then reconnect it.- Making sure the base is plugged in.
A handset can't make or receive calls.	<ul style="list-style-type: none">- Moving the handset closer to the base.
A handset can make calls, but it won't ring.	<ul style="list-style-type: none">- Making sure the ringer is turned on.
A handset is not working.	<ul style="list-style-type: none">- Charging the battery for 15-20 hours.- Checking the battery connection.
A handset says <i>Unavailable</i> .	<ul style="list-style-type: none">- Moving the handset closer to the base.- Seeing if another handset is in Privacy Mode.
No handsets display Caller ID information.	<ul style="list-style-type: none">- Letting calls ring twice before answering.- Making sure your Caller ID service is active.
Caller ID displays briefly & then clears.	<ul style="list-style-type: none">- You may have to change the line mode. Contact Customer Service for instructions.
I can't transfer calls.	<ul style="list-style-type: none">- You may have to reset the handset. Contact Customer Service for instructions.
Two handsets can't talk to the caller.	<ul style="list-style-type: none">- Making sure no handset is in Privacy Mode.
The answering system does not work.	<ul style="list-style-type: none">- Making sure the answering system is on.- Making sure the base is plugged in.
The system won't record messages.	<ul style="list-style-type: none">- Making sure the <i>Record Time</i> is not set to <i>Announce Only</i>.- Deleting messages (memory may be full).
A handset can't access the answering system.	<ul style="list-style-type: none">- Seeing if another handset is using the system.- Making sure the phone is in standby.

If...	Try...
My outgoing message is gone.	- If there was a power failure, you may have to re-record your personal outgoing message.
I can't hear the base speaker.	- Making sure call screening is turned on. - Changing the base speaker volume.
Messages are incomplete.	- The incoming messages may be too long. Remind callers to leave a brief message. - Deleting messages (memory may be full).
When I answer on an extension, the phone keeps ringing (or keeps recording.)	- You may have to change the line mode. Contact Customer Service for instructions

Weak or Hard To Hear Audio

If a caller's voice sounds weak or soft, the signal might be blocked by large metal objects or walls; you might also be too far from the base, or the handset's battery may be weak.

- Try moving around while you're on a call or moving closer to the base to see if the sound gets louder.
- Make sure the handset's battery is fully charged.
- Try adjusting the earpiece volume.

Do you use a T-Coil hearing aid?

- If you have a hearing aid equipped with a telecoil (T-coil) feature, the interaction between the hearing aid & digital cordless phones can cause noise in the handset. If you have a T-coil hearing aid & you have problems with noise on the line, try turning on *T-coil* mode. Open the menu. Select *Handset Setup*, then select *T-coil*.
- Using T-coil mode can shorten the handset's talk time; make sure to watch the battery status and keep the battery charged.

Noise or Static on the Line

Interference is the most common cause of noise or static on a cordless phone. Here are some common sources of interference:

- electrical appliances, especially microwave ovens
- computer equipment, especially wireless LAN equipment and DSL modems
- radio-based wireless devices, such as room monitors, wireless controllers, or wireless headphones or speakers
- fluorescent light fixtures (especially if giving off a buzzing noise)
- other services that use your phone line, like alarm systems, intercom systems, or broadband Internet service

If static is on 1 handset or in 1 location:	If static is on all handsets or in all locations:
<ul style="list-style-type: none">- Check nearby for one of the common interference sources.- Try moving the handset away from a suspected source, or try moving the suspected source so it's not between the handset and the base.- There is always more noise at the edges of the base's range. If an <i>Out of Range</i> message displays, try moving closer to the base.	<ul style="list-style-type: none">- Check near the base for the source of interference.- Try moving the base away from a suspected source, or turn off the source if possible.- If the base has an adjustable antenna, try raising the antenna so it stands straight up.- If you have any service that uses the phone line, you might need a filter (see below).

Installing a Line Filter or DSL Filter

Sometimes, broadband Internet services that use the telephone line can interfere with phones. One of these services—DSL—often causes static on telephones. A DSL filter or telephone line filter usually solves this problem. The technician who installed your DSL service might have left some filters for you; if not, call your DSL provider or look in any electronics store.

Plug the DSL filter into the telephone wall jack and plug your phone's base into the filter. Make a test call to make sure the noise is gone.

Liquid Damage

Moisture and liquid can damage your cordless phone.

- If the exterior housing of the handset or base is exposed to moisture or liquid, wipe off the liquid, and use as normal.
- If moisture or liquid is inside the plastic housing (i.e. liquid can be heard in the phone or liquid has entered the handset battery compartment or vent openings on the base), follow these steps:

Handset	Base
<ol style="list-style-type: none">1. Remove the battery cover and disconnect the battery.2. Let dry for at least 3 days with the battery disconnected and the cover off.3. After the handset dries, reconnect the battery and replace the cover. Recharge the battery fully (15-20 hours) before using.	<ol style="list-style-type: none">1. Disconnect the AC adapter to cut off the power.2. Disconnect the telephone cord.3. Let dry for at least 3 days before reconnecting.

CAUTION! DO NOT use a microwave oven to speed up the drying process. This will cause permanent damage to the handset, base and the microwave oven.

AC Adapter and Battery Information

- Use only the supplied AC adapters. Be sure to use the proper adapter for the base & any chargers.

- Do not place the power cord where it creates a trip hazard or where it could become chafed and create a fire or electrical hazard.

- Do not place the unit in direct sunlight or subject it to high temperatures.

- Fully charged, the battery should provide about 7 hours of talk time and about 6 days of standby time. For best results, return the handset to the cradle after each call to keep it fully charged.

- When the battery gets too

low, the handset shows a low battery alert. If you hear a strange beep during a call, check the display: if you see the low battery alert, finish your conversation as quickly as possible and return the handset to the cradle. If the handset is in standby, none of the keys will operate.

- With normal use, the battery should last about one year. Replace the battery when the talk time becomes short even when the battery is charged. To buy a replacement battery, visit our website listed on the front cover.

AC adapter		Base/Charger
	Part number	AAD-041S(M) / AAD-600S(M)
	Input voltage	240V AC, 50 Hz
	Output voltage	9V DC @350mA / 9V DC @210mA
Battery pack	Part number	BT-694m
	Capacity	300mAh, 2.4V DC

Rechargeable Nickel-Metal Hydride Battery Warning

- This equipment contains a rechargeable Nickel-Metal Hydride (Ni-MH) battery.
- Do not short-circuit the battery.
- The rechargeable Ni-MH batteries contained in this equipment may explode if disposed of in a fire.
- Do not charge the battery used in this equipment in any charger other than the one designed to charge this battery as specified in the owner's manual. Using another charger may damage the battery or cause it to explode.

Mounting the Base on a Wall

You can mount your base to any standard telephone wall plate using the included wall mount bracket.

1. Route the AC adapter and the telephone cord through the hole of the wall mount bracket.

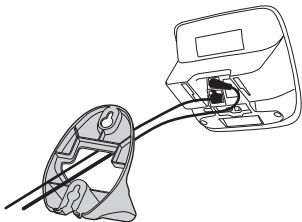

2. Connect the AC adapter and the telephone cords.

3. Line up the four tabs on the wall mount bracket (two at the top and two at the bottom) with the four notches on the bottom of the base. Slide the bracket into place

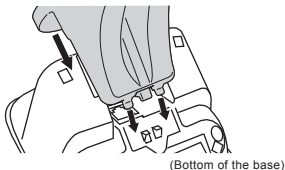

4. Hook the AC adapter cord into the smaller notch at the bottom of the bracket, and let the cord hang below the bracket.

5. Plug the telephone cord into the wall jack. Hook both sides of the telephone cord into the larger notch OR tuck the excess cord into the open space in the bracket.

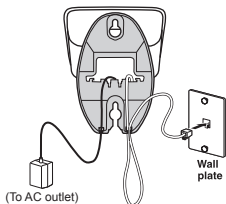

6. Place the mounting slots over the pins on the wall plate.

7. Slide the base down to lock it into place.

8. Removing the wall-mount bracket: At the bottom of the base, lift up on the release latch between the two bottom tabs and push the bracket up.

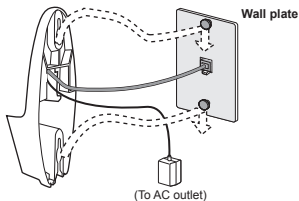

Mounting the phone directly on the wall

Before doing this, consider the following:

- Avoid electrical cables, pipes, or other items behind the mounting location that could cause a hazard when inserting screws into the wall.
- Mount your phone within distance of a working phone jack.
- Make sure the wall material is capable of supporting the weight of the base and handset.
- Use screws with anchoring devices suitable for the wall material where the base unit will be placed.
- Be sure the wall is capable of supporting the weight of the phone, and use the proper type of anchoring device for the wall material.
- Insert two #10 screws (minimum length of 35mm, not supplied) into the wall, 100mm apart.
- Leave the screw heads 3mm away from the wall to allow room for mounting the phone.
- Align the mounting slots over the screws and slide the base down into place as shown above.

INDEX

A	
Any Key Answer.....	11
Answer Machine	
Call Screen.....	20, 23
Get Messages.....	22
Greeting (Outgoing Message).....	21
Record / Change / Delete.....	22
On/Off.....	20
Ring time / Record Time.....	20
Record Time.....	20
Remote Operation from Handset.....	21
Away from Home.....	24
Security Code.....	20, 24
Setup.....	20
AutoTalk.....	11
B	
Banner.....	11
Battery	
Preparing and charging.....	5
Replacement and handling.....	29
C	
Caller ID	
Caller ID service.....	13
Calling.....	14
Call Waiting.....	15
Deleting.....	14
Storing.....	14
Using.....	14
Viewing.....	14
Call transfer feature.....	19
Chain dialing.....	17
Clock (see Day & Time)	
Conference Calling.....	17
D	
Day & Time.....	11
E, F, G	
Earpiece volume.....	13
Find handset.....	16
H	
Hands-free conversation.....	13

I, J, K, L	
Intercom.....	8, 18
Insert Zero.....	12
Keypad Lock.....	9
Key Touch Tone.....	11
Line Filter.....	28
Liquid Damage.....	28
M, N, O	
Making a call.....	13
Mute.....	9, 13
Noise.....	27
P, Q	
Package contents.....	3
Paging handset (see Find handset)	
Phonebook.....	15
Editing.....	12, 16
Erasing.....	16
Making calls.....	15
Storing.....	16
Viewing.....	15
Chain dialing.....	17
Privacy mode.....	17
R	
Receiving a call.....	13
Redialing a call.....	13
Ringer volume.....	13
S	
Setting up	
base unit.....	5, 6
extra handset.....	5, 6
handset.....	5, 6
Static (see Noise)	
T, U, V	
Transferring a call.....	19
Troubleshooting.....	25
Voice Mail.....	12, 19
Programming.....	19
W, X, Y, Z	
Wall Mounting the Base.....	30
Warranty.....	34

ONE-YEAR LIMITED WARRANTY

UNIDEN DECT 1535, DECT 1535+1/+2/+3

IMPORTANT Satisfactory evidence of the original purchase is required for warranty service

Please refer to our Uniden website for any details or warranty durations offered in addition to those contained below.

Warrantor: The warrantor is either Uniden Australia Pty Limited ABN 58 001 865 498 (“Uniden Aust”) or Uniden New Zealand Limited (“Uniden NZ”) as the case may be.

Terms of Warranty: Uniden Aust/NZ warrants to the original retail purchaser only that the DECT 1535, DECT1535+1/+2/+3 (“the Product”), will be free from defects in materials and craftsmanship for the duration of the warranty period, subject to the limitations and exclusions set out below.

Warranty period: This warranty to the original retail purchaser is only valid in the original country of purchase for a Product first purchased either in Australia or New Zealand and will expire one (1) year from the date of the original retail sale.

If a warranty claim is made, this warranty will not apply if the Product is found by Uniden to be:

- (A) Damaged or not maintained in a reasonable manner or as recommended in the relevant Uniden Owner’s Manual;
- (B) Modified, altered or used as part of any conversion kits, subassemblies or any configurations not sold by Uniden Aust or Uniden NZ;
- (C) Improperly installed contrary to instructions contained in the relevant Owner’s Manual
- (D) Repaired by someone other than an authorized Uniden Repair Agent in relation to a defect or malfunction covered by this warranty; or
- (E) Used in conjunction with any equipment, parts or a system not manufactured by Uniden.

Parts Covered: This warranty covers the Product and included accessories.

User-generated Data: This warranty does not cover any claimed loss of or damage to user-generated data (including but without limitation phone numbers, addresses and images) that may be stored on your Product.

Statement of Remedy: If the Product is found not to conform to this warranty as stated above, the Warrantor, at its discretion, will either repair the defect or replace the Product without any charge for parts or service. This warranty does not include any reimbursement or payment of any consequential damages claimed to arise from a Product's failure to comply with the warranty.

Our goods come with guarantees that cannot be excluded under the Australian Consumer Law. You are entitled to a replacement or refund for a major failure and for compensation for any other reasonably foreseeable loss or damage. You are also entitled to have the goods repaired or replaced if the goods fail to be of acceptable quality and the failure does not amount to a major failure.

This warranty is in addition to and sits alongside your rights under either the COMPETITION AND CONSUMER ACT 2010 (Australia) or the CONSUMER GUARANTEES ACT (New Zealand) as the case may be, none of which can be excluded.

Procedure for obtaining warranty service: Depending on the country in which the Product was first purchased, if you believe that your Product does not conform with this warranty, you should deliver the Product, together with satisfactory evidence of your original purchase (such as a legible copy of the sales docket) to Uniden at the addresses shown below. You should contact Uniden regarding any compensation that may be payable for your expenses incurred in making a warranty claim. Prior to delivery, we recommend that you make a backup copy of any phone numbers, images or other data stored on your Product, in case it is lost or damaged during warranty service.

UNIDEN AUSTRALIA PTY LTD

Service Division
345 Princes Highway,
Rockdale, NSW 2216
Phone number: 1300 366 895
Email address: custservice@uniden.com.au

UNIDEN NEW ZEALAND LTD

Service Division
150 Harris Road, East Tamaki
Auckland 2013
Phone number: (09) 273 8377
Email address: service@uniden.co.nz

THANK YOU FOR BUYING A UNIDEN PRODUCT.

Uniden[®]